

 **AKVATERM**

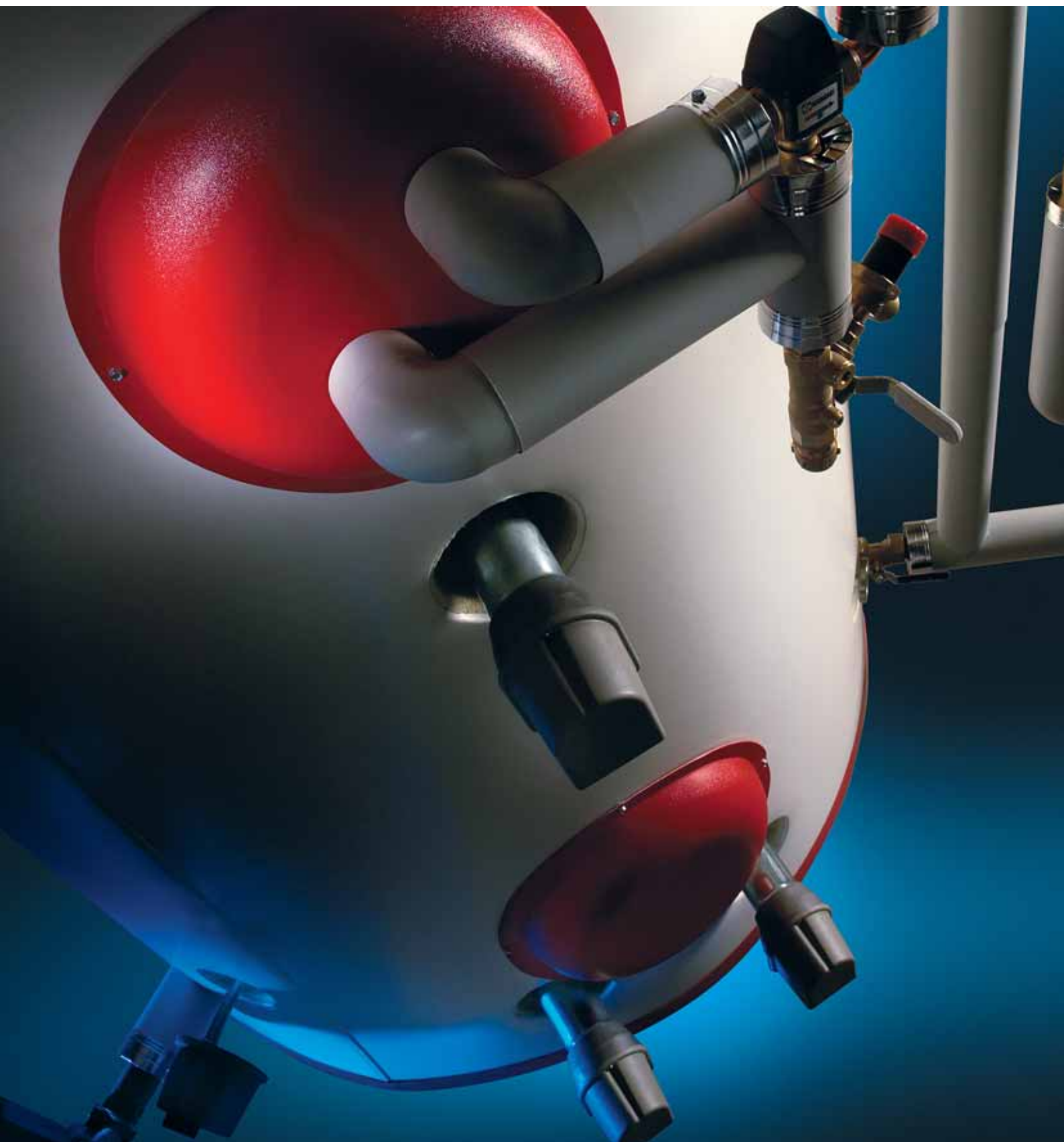

Warm home

Heating made to measure

Akvaterm represents the modern ecologic heating technologies enabling the most efficient energy production storing the heat and distributing constant steady heat as needed for pleasant living. The Akvaterm accumulator tank is suitable for use with many different heating sources, regardless of the heating system or fuel.

The capacities of standard Akvaterm hot water accumulator tank models for houses and buildings range from 300 litres to 4000 litres. Akvaterm also produces renovation accumulator tanks for upgrade and renovation projects as well as special accumulator tanks whose capacity, units and hot water coils are manufactured according to the customer's requirements.



AKVA Standard Accumulator Tank

Capacity 300-4000 litres. The insulation is 100 mm seamless polyurethane faced with steel sheet. Detachable side panels are also an option. An uninsulated accumulator tank coated with corrosion protection paint can also be delivered. The upper hatch has a standard hot water coil. A domestic hot water pre-heating coil, a solar heating

coil, heat collector exchanger and other units can be placed in the lower hatch. Below are 2" units for the electrical resistors used during the night. The resistors used during the day are in the centre, and built-in guide pipes ensure the proper layering of heat.



AKVA 1500 EK

MODEL	DIAMETER mm	HEIGHT mm	WEIGHT kg	RESISTOR UNITS
AKVA 300 EK	710	2050	130	2
AKVA 500 EK	800	2050	155	2
AKVA 750 EK	950	2050	200	2
AKVA 1000 EK	1050	2100	230	2
AKVA 1500 EK	1250	2150	280	3
AKVA 2000 EK	1400	2200	330	4
AKVA 2500 EK	1500	2250	360	4
AKVA 3000 EK	1600	2300	400	4
AKVA 4000 EK	1800	2350	480	6
AKVA 5000 EK	2000	2500	600	6

EK = isolated and with one coil
E = isolated

Diameter 200 mm smaller without insulation

- Hatch (2 pcs) \varnothing 200 mm
- Heating Circuit Unit + Guide Pipe 1 1/4 "
- Drain coupling 1 "
- Thermometer/Thermostat Unit (4 pcs) 3/4 "
- Tank unit + Guide Pipe 1 1/4 "
- Electrical Resistor Unit (2-4 pcs) 2 "
- Domestic hot water coil, finned copper \varnothing 22 mm 3/4 ", M Capacity, standard 35 l/min, +5°C/+ 55°C/+75°C 90 kW Structural pressure 10 bar
- Pressure Relief / Air Bleeder 1 "
- Polyurethane Insulation 100 mm
- Coating, coated galvanised tin sheet 0,5 mm
- Tank: maximum structural pressure 1,5 bar maximum temperature +110 °C

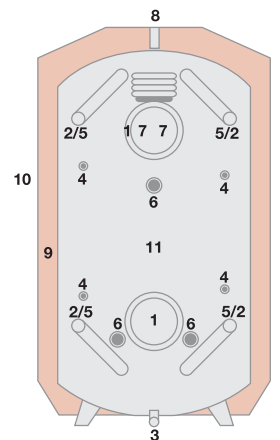

AKVASAN Renovation Accumulator Tank

Developed for constrained spaces and narrow openings, this model's diameter is only 800 mm. The AKVASAN 0.5 series is particularly compact; the advantages of the efficient cylinder format have been retained. The insulation is the same as in the standard accumulator tanks, but its thickness is 50 mm due to the smaller surface area. The EK models are equipped with a domestic hot water coil, as well as

daytime and nighttime resistor units. When further equipped with an electric resistor, its characteristics make it an excellent domestic hot water heater. If only domestic hot water is required, for example during the summer, the E model can be disconnected. An additional accumulator tank for double boilers: excellent operating efficiency, clean burning, no boiling in the boiler.



AKVASAN 0,7 EK

AKVASAN 0,7 E

MODEL	DIAMETER mm	HEIGHT mm	WEIGHT kg	RESISTOR UNITS
AKVASAN 0,5 EK	810	1550	130	2
AKVASAN 0,5 E	810	1550	120	1
AKVASAN 0,7 EK	810	2050	160	2
AKVASAN 0,7 E	810	2050	150	1

EK = isolated and with one coil E = isolated

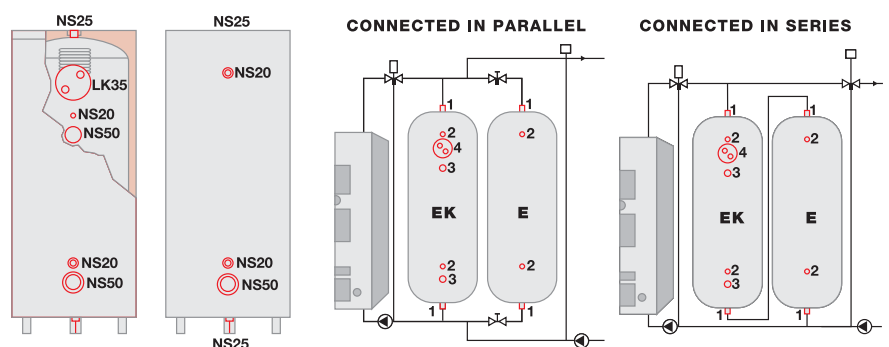

AKVANTTI oval accumulator tank

For new construction and renovations. Capacities 1400 litres, 2000 litres and 2400 litres. The most efficient hot water coil on the market (45 l/min), also available without a domestic hot water coil. The depth is only 810 mm.



AKVANTTI 2000 EK



AKVANTTI 1400 EK

MODEL	HEIGHT/WIDTH mm	DEPTH mm	WEIGHT kg	RESISTOR UNITS
AKVANTTI 1400 EK	1660/1630	810	420	3
AKVANTTI 1400 E	1660/1630	810	410	3
AKVANTTI 2000 EK	1840/2060	810	500	4
AKVANTTI 2000 E	1840/2060	810	490	4
AKVANTTI 2400 EK	2160/2060	810	560	4
AKVANTTI 2400 E	2160/2060	810 </td <td>550</td> <td>4</td>	550	4

EK = isolated and with one coil E = isolated

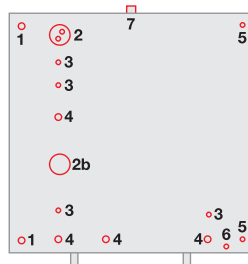

AKVANTTI 2000 EK, 2400 EK, PIPE CONNECTIONS FROM SIDE:

1. Tank unit 2"
2. Domestic hot water coil 45l/min, units 3/4", 2 pcs
2b. Connection for second coil
3. Thermometer/Thermostat Unit 3/4"
4. Electrical Resistor Unit 2", 4 pcs
5. Heating Circuit Unit 1 1/4"
6. Drain coupling 1"
7. Air Bleeder 1"

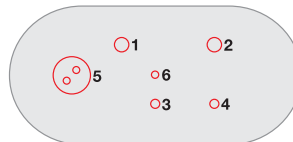

AKVANTTI 1400 EK, CONNECTIONS FROM TOP:

1. Entry from boiler 2"
2. Return to boiler 2"
3. Exit to heating circuit 1 1/4"
4. Return from heating circuit .. 1 1/4"
5. Domestic hot water coil 45 l/min units 3/4", 2 pcs
6. Air Bleeder 1"

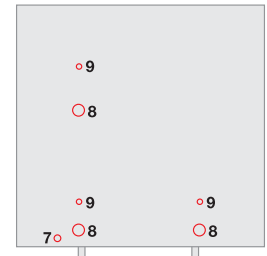

AKVANTTI 1400 EK, PIPE CONNECTIONS FROM SIDE:

7. Drain coupling 1"
8. Electrical Resistor Unit 2", 3 pcs
9. Thermostat Unit/Thermometer Unit... 3/4"

Accumulator Tanks for various needs

Made suitable for various uses. The structural pressure is usually 3 or 4 bar. The capacity, hatches, units, hot water coils and other units are manufactured according to the customer's requirements.



Cold Storage Tanks and Pressure Vessels

Cold storage tanks, such as those made with stainless steel, are tailored for our customers according to the functional application. Storage tanks and pressure vessels can be used as storage units for various raw materials, as cold storages, equalising tanks, in recovery systems, and for other purposes. All necessary additional accessories, such as extra hatches, units, coils, mounting brackets etc. are included when ordering the aforementioned tanks. The maximum diameter is 2400 mm.



Electrical accessories

The accumulator's electric resistor units can be factory-installed. The resistor material is high-quality Incoloy 825. The night electricity accumulator's accessories include 2-3 electric resistors for nighttime use as well as daytime resistors. The delivery also includes thermostats for nighttime and daytime use, manufactured to comply with the Finnish Electricity Association's drawing no. SLY 3.2,

as well as a single overheating protector. If necessary the accumulator tank can be supplied with its own control panel. The accumulators' electrification can also be carried out according to the customer's preferences.



Hot water coil



Besides the standard coil, AKVA hot water coils are manufactured as ø 22 mm finned copper tubes for flows of 20-200 l/min (capacity 50-500 kW) according to the customer's dimensions. Structural pressure 10 bar.

MODEL	CAPACITY kw	DIAMETER mm	LENGTH mm	UNIT R" male	FLOW l/min
AKVA LK 35	90	160	750	3/4	35
AKVA LK 45	120	160	950	3/4	45
AKVA LK 60	150	160	1250	1	60
AKVA LK 80	205	250	900	1 1/4	80
AKVA LK 100	255	300	1000	1 1/2	100
AKVA LK 120	310	300	1100	2	120

Akvaterm – the essence of heating



Hot water is a basic prerequisite for practical and comfortable living. An essential feature of modern and energy-saving heating technologies for houses and buildings is the accumulation of heat and its transfer through water.

Thanks to water's high heat retention capacity, the connection

of an Akvaterm accumulator tank to the heating system significantly raises the utilisation efficiency, lowers energy costs and reduced environmental emissions.

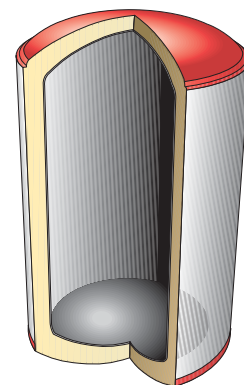

100 mm saumaton uretaanieristys minimoi lämpöhäviöt.

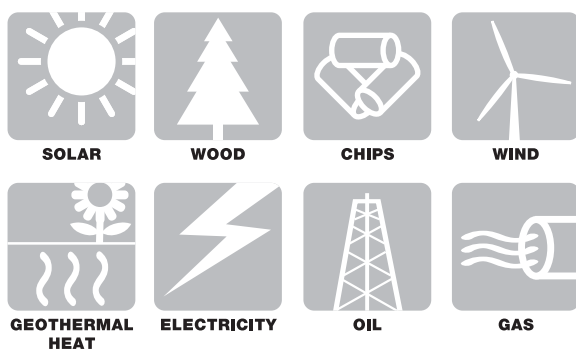

The use of an Akvaterm accumulator tank is independent of the heating system or energy source. Besides the solar, wood, chips, wind or geothermal heat, the heating source can be

traditional electricity, oil or gas heating, or their combinations. If required, energy sources can be modified or the heating system can be supplemented.

Akvaterm is part of an entity that facilitates the production of pleasant and balanced heating for living, as well as domestic hot water, with the same system.



AKVATERM OY • Jänismaantie 12 • FI-67800 Kokkola • FINLAND
Tel. +358 (0)6 824 4200 • Fax +358 (0)6 824 4224
info@akvaterm.fi • www.akvaterm.fi